

# II TROFEO VIA VERDE DE LA CAMPINA MTBO

INTERNATIONAL ORIENTEERING EVENT - I PRUEBA DE LIGA ESPAÑOLA MTBO 2019

## WMS & YGS WORLD MASTERS SERIES YOUNG GUNS SERIES



**FINAL BULLETIN**

PINTURA de Lucie-Long (www.lucielong.com)



FUENTES MARCHENA LA LUISIANA

**SEVILLA 29-30-31 MARZO 2019 WWW.MONTELLANO-O.ES**



**ALL THE PAGES WHERE CHANGES HAVE BEEN MADE  
SINCE THE LAST BULLETIN ARE MARKED WITH THIS STAR**

<b>CONTENT</b>	<b>2</b>
<b>THANK YOU <i>Lucie Llong</i></b>	<b>3</b>
<b>ORGANIZERS</b>	<b>4</b>
<b>COLLABORATORS AND SPONSORS</b>	<b>5</b>
<b>PRESENTATION OF THE EVENT</b>	<b>6</b>
<b>SITUATION MAP</b>	<b>7</b>
★ <b>PROGRAM</b>	<b>8</b>
<b>RULES, RANKING INFORMATION</b>	<b>9</b>
<b>CATEGORIES AND ENTRY FEES</b>	<b>10</b>
<b>TIMING, RESULTS AND FOLLOW-UP</b>	<b>11</b>
<b>ENTRY, PAYMENTS AND INVOICE</b>	<b>12</b>
<b>MAPMAKER TECHNICAL INFORMATION</b>	<b>13</b>
★ <b>COURSE PLANNER TECHNICAL INFORMATION</b>	<b>15</b>
★ <b>ORGANIZATION INFORMATION</b>	<b>17</b>
★ <b><u>INFORMATION FINAL BULLETIN</u></b>	<b>21</b>
<b>EVENT SERVICES</b>	<b>22</b>
<b>PRIZES, TRAINING MAPS, NEXT PUBLIC., CONTACTS</b>	<b>28</b>



**LUCIE LLONG** FRENCH PAINTER OF THE "MOVEMENT"



**Lucie LLONG** is a French painter and sculptor, specialized in sports subjects.

She has accepted that her work be used "VTT" (mixed technique, 60x40cm) for the poster of the first Spanish League event of MTBO 2019.

At the awards ceremony each Elite champion will be given a reproduction of the painting signed by the artist.

**We thank Lucie Llong** for her collaboration with the Spanish MTBO, and her unconditional dedication to promoting sports through art.

<https://luciellong.com/>



**DIRECTOR AREA**

**EVENT DIRECTOR**  
**JUDGE CONTROLLER**  
**TECNICIAN TIMER**

MAGALI SIMONIN COLOMER  
 JESÚS DE MIGUEL REY  
 ABEL J. OTERO RAMÍREZ

**TECHNICAL AREA**

**MAPMAKER**  
**COURSE PLANNER**  
**TECHNICIAN DIRECTOR**  
**TECHNICIAN SPORTIDENT**  
**TECHNICIAN GPS TRACKING**

RESCNAV  
 JUAN FRANCISCO ABELLÁN  
 JUAN DANIEL IGLESIAS  
 ABEL J. OTERO  
 ENRIQUE ROLLAND

**LOGISTIC AREA**

**SECRETARY**  
**LOGISTIC AND PARKING**  
**DEPARTURE-FINISH**  
**REFITTING**  
**CATERING BOOKING**  
**KINDERGARTEN**  
**HARD FLOOR**  
**SPONSORS**

EDUARDO GAMARRA  
 PEDRO TELLEZ Y ANTONIO DELGADO  
 MANU MARMÓL  
 LOLI GARCÍA  
 JUAN ANTONIO MUÑOZ  
 MARI CARMEN TELLEZ  
 CHARI BARRERA  
 DANIEL RAMOS

**COMMUNICATION AREA**

**TECHNICIAN COMMUNICATION**  
**SPEAKER**  
**TELEVISION**  
**PHOTO AND VIDEO**  
**SOCIAL NETWORKS**  
**PROTOCOL AND INFORMATION POINT**

FRAN RODRIGUEZ  
 JOSÉ PINTO  
 RTV MARCHENA Y RTV FUENTES  
 DOS CAMARAS SL  
 EDUARDO GAMARRA  
 SUSANA REGUERA

**SECURITY AREA**

**SECURITY DIRECTOR**  
**HEALTH SERVICES**  
**PUBLIC SECURITY**

SERGIO RODRIGUEZ  
 CRUZ ROJA  
 GUARDIA CIVIL  
 POLICIA LOCAL  
 PROTECCIÓN CIVIL

Montellano-O club appreciates the voluntary participation of its members:  
 more than 70 people who make possible the organization of this international event.

# COLLABORATORS

II TROFEO VÍA VERDE DE LA CAMPIÑA  
I LE - I LA - II WMS - I YGS MTBO 2019



AYUNT. FUENTES  
DE ANDALUCÍA



AYUNT. MARCHENA



AYUNT. LA LUISIANA



# SPONSORS

II TROFEO VÍA VERDE DE LA CAMPIÑA  
I LE - I LA - II WMS - I YGS MTBO 2019



www.molinolaboticaria.com

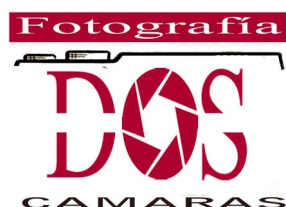



## II TROFEO VÍA VERDE DE LA CAMPIÑA MARCH 29-30-31, 2019 PROVINCE OF SEVILLE (Fuentes de Andalucía, Marchena, La Luisiana)

Three City Councils of the Sevillian “Campiña” (Fuentes de Andalucía, Marchena and La Luisiana) have opened the doors of their villages to receive the first national event of the year of orienteering on bike, being in turn the second event of the 2019 World Masters Series and the first event of the 2019 Young Guns Series.

Located in the center of these three municipalities, the Via Verde de la Campiña is an old road of railroad connecting Cordoba to Marchena with a total length of 91km. Landscapes with moderate unevenness of the countryside and its complex network of roads makes it idyllic for the practice of MTBO.

The area is perfectly communicated, being located only 35 minutes by car from Seville, 40 minutes from Cordoba and 1h30 from Málaga with its free highways. Seville and Malaga have airports with national and international flights to all countries of Europe.

We encourage you to live a great experience:

- . New orienteering maps with labyrinthine road network
- . Course with endless choice of route and change of rhythm
- . Digital technology at the service of orienteering to feel the emotion of direct

See you soon!



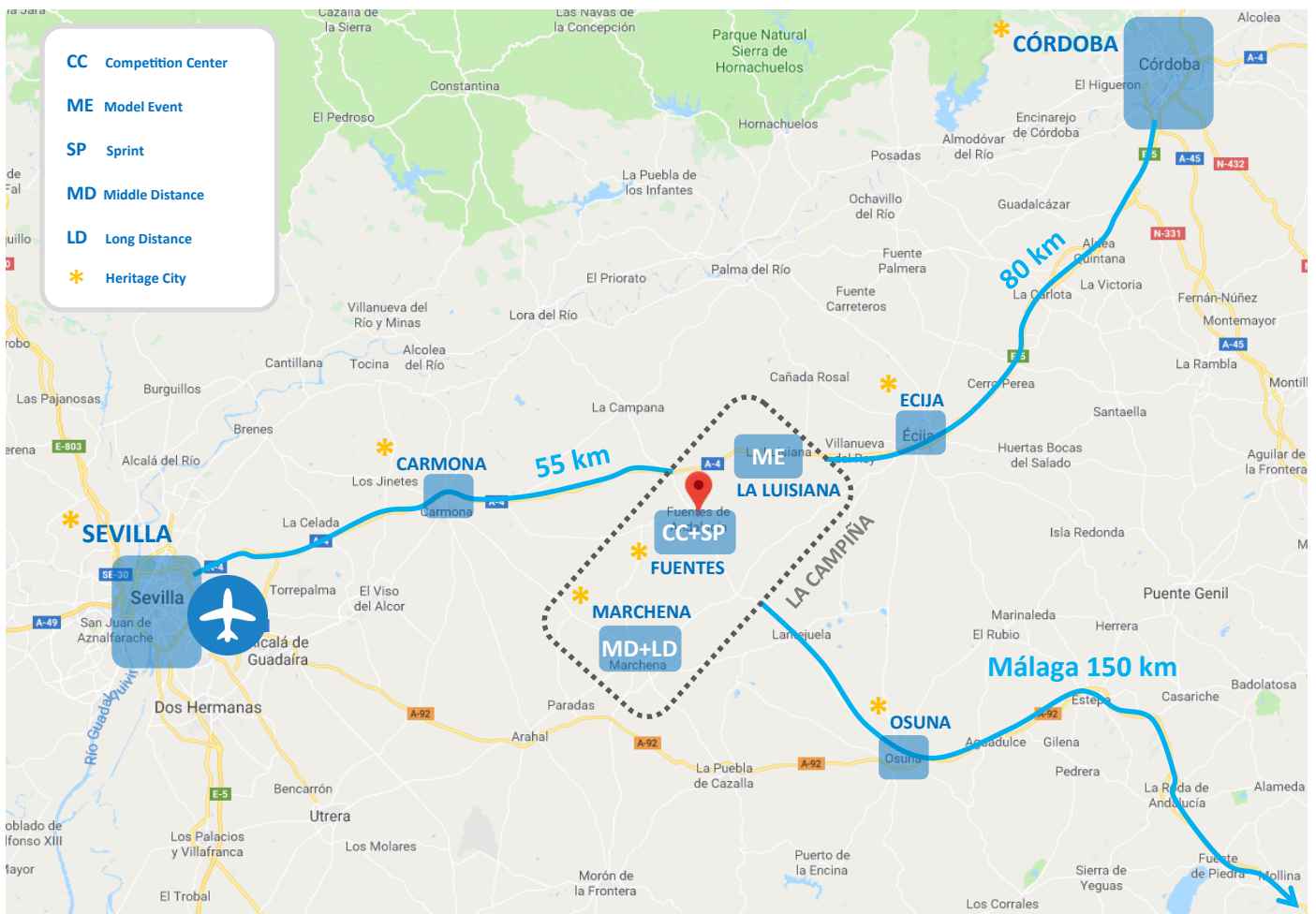

## AIRPORTS

SEVILLE 55 Km / MALAGA 150 Km

## FASTROADS

A4 FREE TO SEVILLE 55 Km  
A4 FREE TO CORDOBA 80 Km  
A45+A92 FREE TO MALAGA 150 Km

## BUS TRANSPORT

BUS FROM SEVILLE "PLAZA DE ARMAS" TO LA LUISIANA 45mn  
BUS FROM LA LUISIANA TO FUENTES DE AND. 15mn

## HOTEL

### HOTELS

Marchena - Carmona - Écija - Osuna - Sevilla

### BED AND BREAKFAST

Fuentes de Andalucía - La Luisiana - Marchena - Carmona - Écija - Osuna

### HARD FLOOR

Fuentes de Andalucía (book in the registration form)

## CAMPINGCAR

### SERVICE POINT + PARKING

Fuentes de Andalucía (5mn walk from the Competition Center)

**26/12 WEDNESDAY****08:00 Registration opening for foreigners**[www.orienteingonline.net](http://www.orienteingonline.net)**08:00 Registration opening for Spanish (and Portuguese federated)**[www.sico.fedo.org](http://www.sico.fedo.org)**23/03 SATURDAY****23:59 Registration closed****26/03 TUESDAY****10:00** Publication of departure times**29/03 FRIDAY****12:00 Opening of Fuentes Competition Center** (bar / food)  
and the hard floor at Fuentes Sport Center**13:00-15:00** Catering lunch service at Fuentes Competition Center *RESERVE***15:00 First Start Model Event La Luisiana****17:30** Closing of Model Event**21:00** Closing of Fuentes Competition Center**30/03 SATURDAY****09:00 Opening of Fuentes Competition Center** (bar/ food)**09:30 Opening of Marchena Temporary Competition Center****10:30 First pre-exit** (25min by bike)**11:00 First start Middle Distance** (start per hour) *SPORTIDENT SIAC / GPS TRACK.***12:30** Last Start**14:00 Closing of Middle Distance****13:00-15:00** Catering lunch service at Fuentes Competition Center *RESERVE***15:30 Quarantine zone Sprint in Fuentes** (3min by bike from Comp. C.)**16:00 First start Sprint** (start per hour) *SPORTIDENT SIAC / GPS TRACK.*with *closing traffic* for all vehicles in the competition area**18:15 Closing of Sprint****19:30 FEDO MTBO 2018 awards ceremony at C.C. of Fuentes****21:00** Closing of Fuentes Competition Center**31/03 SUNDAY****09:00 Opening of Fuentes Competition Center** (bar/ food)**08:00 Opening of Marchena Temporary Competition Center****09:10 First pre-exit** (15min by bike)**09:30 Start Long Distance** *SPORTIDENT SIAC / GPS TRACK.)*

Chasing start one man relay / Start per hour

**13:00 Closing of Long Distance****13:30 Award ceremony II Vía Verde de la Campiña Trophy****13:30-15:00** Catering lunch service at Fuentes Competition Center *RESERVE***16:00 Closing of Fuentes Competition Center.**



THE COMPETITION WILL BE REGULATED BY :

**Bicycle Orienteering Regulation (FEDO)**  
**Rules of the Spanish Bike Orienteering League 2019 (FEDO)**  
**FEDO-FPO Protocol**

For the not contemplated, the international Rules of IOF will apply

<https://www.fedo.org/web/competicion/mtbo/reglamentos>

**RANKING INFORMATION**

**MD+SP+LD POINTS FOR**

**Spanish League of MTBO 2019 (FEDO)**  
**Andalusia League of MTBO 2019 (FADO)**  
**Seville Provincial League of MTBO 2019 (Delegación Sevillana FADO)**

**MD+SP POINTS FOR**

**International League WMS of MTBO 2019 (IOF)**  
**International League YGS of MTBO 2019 (IOF)**

**COURSES FOR:**

CATEGORIES	YEAR OF BIRTH	FEDO			FADO			IOF		
		Middle	Long	Sprint	Middle	Long	Sprint	Middle	Long	Sprint
M/F-12	Born in 2006 and later				X	X	X	X		X
M/F-15	Born in 2004 and later	X	X	X	X	X	X	X		X
M/F-17	Born in 2002 and 2003	X	X	X	X	X	X	X		X
M/F-20	Born in 1999, 2000, 2001	X	X	X	X	X	X	X		X
M/F-21	Without age limit	X	X	X	X	X	X	X		X
M/F-E	Without age limit	X	X	X				X		X
M/F-40	Born in 1979 and earlier	X	X	X	X	X	X	X		X
M/F-50	Born in 1969 and earlier	X	X	X	X	X	X	X		X
M/F-60	Born in 1959 and earlier	X	X	X	X	X	X	X		X
M/F-70	Born in 1949 and earlier							X		X
ABS. PAREJAS	Any age and gender	X	X	X	X	X	X			
INI. PAREJAS	Any age and gender									
M/F-INI	Any age									
M/F-PROM	Any age									

● OFFICIAL CATEGORIES FEDO

● UNOFFICIAL CATEGORIES FEDO

CATEGORIES	WITH LICENSE FEDO				WITHOUT LICENSE FEDO					FOREIGNERS	
	MD+SP+LD	MD	SP	LD	MD+SP+LD	MD+SP	MD	SP	LD	MD+SP+LD	MD+SP
M/F-12	16	7	5	7	22	15	10	8	10	22	15
M/F-15	16	7	5	7	31	20	15	13	15	22	15
M/F-17	16	7	5	7	31	20	15	13	15	22	15
M/F-20	16	7	5	7	31	20	15	13	15	22	15
M/F-21	22	9	7	9	37	24	17	15	17	30	17
M/F-E	22	9	7	9	37	24	17	15	17	30	17
M/F-40	22	9	7	9	37	24	17	15	17	30	17
M/F-50	22	9	7	9	37	24	17	15	17	30	17
M/F-60	22	9	7	9	37	24	17	15	17	30	17
M/F-70	16	7	5	7	22	15	10	8	10	22	15
ABS. PAREJAS	22	9	7	9	37	24	17	15	17	30	17
INI. PAREJAS	16	7	5	7	22	15	10	8	10	22	15
M/F-INI	16	7	5	7	22	15	10	8	10	22	15
M/F-PROM	16	7	5	7	22	15	10	8	10	22	15

## UNDERSTAND THE CATEGORIES :

### "INICIACIÓN":

For those who start this sport, any age.

"Iniciacion parejas" for couple allows to start accompanied (2 pers., any age and gender: ex. mother+child).

### "PROMOCIÓN":

For those who have a medium level, any age.

## UNDERSTAND THE ENTRY FEES :

The cost of insurance is always included in the rate / Prices are in euros

**Registering for the 3 events allows you to save 3 euros**

### WITH FEDO LICENSE:

All athletes with FEDO License (Federación Española De Orientación) compete with the **lowest entry fees** (they are already insured). The **portuguese licensed by the FPO** benefit from these entry fees (according to FEDO-FPO protocol).

### WITHOUT FEDO LICENSE:

**Official categories FEDO:** The price of the insurance, included in the entry fees, is 15 euros for the 3 races (2 days) or 8 euros for 1 day of competition. They are the highest entry fees; Compete in unofficial categories is more economical.

**Unofficial categories FEDO:** The price of insurance, included in the entry fees, is 6 euros for the 3 races (2 days) or 3 euros for 1 day of competition.

### FOREIGNERS:

**Official categories FEDO:** The price of insurance for foreign athlete (excluding Portuguese with FPO license), included in the entry fees is 6 euros for the 3 races (2 days) or 3 euros for 1 day.

**Unofficial categories FEDO:** The price of insurance for foreign athlete, included in the entry fees, is 3 euros for the 3 races (2 days) or 2 euros for 1 day of competition.

## MODEL EVENT

**La Luisiana Fryday 29/03 - First start at 15:00 - Closing event at 17:00**

Short training race with standardized control. Without SportIdent timing.

**ENTRY FEES 2 EUROS** (insurance included)

**TIMING TECHNICAL****ABEL J. OTERO RAMÍREZ****TIMING SYSTEM****SPORTIDENT Air+ for all categories****SI CARD ALLOWED****SIAC**

*The organization will **lend** a SIAC to anyone who does not have one with the only deposit of 70 euros to favor equality throughout the competition.*

**FINISH CONTROL****WIRELESS SPORTIDENT**

Base BS11-BL (wireless finish) will be used.

**RESULTS AND FOLLOW-UP**

**FUENTES DE ANDALUCÍA COMPETITION CENTER WILL DISPOSE OF LARGE SCREENS OF TELEVISION FOR THE LIVE RETRANSMISSION OF ALL IMAGES (VIDEO IMAGES, GPS MONITORING AND RESULTS)**

**- RESULTS IN REAL TIME**

The results will be published in real time at <http://liveresultat.orientering.se>

**- LIVE VIDEO**

Live broadcast of the field video of each competition commented by **the speaker José Pinto** (con entrevistas y análisis de los resultados).

**- RADIO-CONTROLS**

At intermediate points of the upper course, Radio Control systems will be installed. The information can be viewed in real time at <http://liveresultat.orientering.se>

**- GPS TRACKING SYSTEM**

**30 athletes from the most competitive official categories will have a GPS tracking system, allowing retransmit in real time his career.**

To ensure Fair Play all races with exits in hours will have a quarantine zone: you can not use electronic devices in this area (smartphone, smartwatch, etc ...).

**Do not respecting this rule will train the disqualification of the athlete.**

**- FINAL RESULTS**

After finishing each race the results will be publishing in:

- . Competition Center of Fuentes de Andalucía
- . <http://liveresultat.orientering.se>
- . WinSplits Online <http://obasen.orientering.se/winsplits/online/sv/default.asp>
- . Website [www.montellano-o.es](http://www.montellano-o.es)

START 26/12/2018 9:00 - END 23/03/2019 23:59

OUT OF ENTRY TIME WILL NOT BE ADMITTED**SICO-FEDO**<https://sico.fedo.org>  
FOR SPANISH (WITH AND WITHOUT LICENSE FEDO)  
FOR PORTUGUESE (ONLY WITH FPO LICENSE)**ORIENTEERING**<http://www.orienteingonline.net>  
FOR FOREIGNERSON ENTRY FORM REQUEST THE FREE SIAC CLUB RENTAL (ONE AUTHORIZED SI-CARD)  
DEPOSIT OF 70 EUROS OBLIGATORY WHEN COLLECTING THE SIAC AT THE COMPETITION CENTERRemember to request the desired services on the entry form  
(catering, T-shirt, kingergarten, hard floor...)**PAYMENT****SICO-FEDO**

PAYMENT WITH CARD OR TRANSFER

**ORIENTEERING**PAYMENT WITH CARD ([www.montellano-o.es](http://www.montellano-o.es)) OR TRANSFER**BANCO SABADELL - CLUB MONTELLANO ORIENTACION**

IBAN ES08 0081 5576 0400 0102 0509

BIC BSABESBB

IF THE PAYMENT IS BY TRANSFER, SEND THE PAYMENT JUSTIFIED TO  
[inscripcion@montellano-o.es](mailto:inscripcion@montellano-o.es)

SECURE ONLINE CARD PAYMENT - BANCO SABADELL NEW SYSTEM: from the end of January

[www.montellano-o.es](http://www.montellano-o.es)**INVOICE****INVOICE FORM**

## MODEL EVENT

### RULE ISMTBO

SCALE: 1:15000

EQUIDISTANCE: 5 METERS

HALF PENDING: 1.4%

LOCATION: LA LUISIANA (SEVILLE)



## SPRINT

### RULE ISSOM adapted to MTBO

SCALE: 1:4000

EQUIDISTANCE: 2 METROS

HALF PENDING: 3,6%

LOCATION: FUENTES DE ANDALUCÍA (SEVILLE)

100% urban map, where alternating asphaltting and cobbled areas with optimal cyclability. Broad Street width, with few narrow áreas, presenting corners with long streets.

There is only one road cut to the competition properly expressed in the map and controlled during the course by judges and volunteers.

### SPECIAL SYMBOLS:

	ESCALERAS/STAIRS
	SETOS/HEDGES
	PASO BAJO EDIFICIOS/CANOPY
	MOBILIARIO URBANO/ URBAN ITEMS

### REMEMBER:

**CROSS:** Forbidden to pass from this point

**SHORT LINE:** There is an obstacle, but you can pass, for example a chain that cross the road (you can pass it up or down)

**ZIGZAG OR GRATED:** Prohibited areas

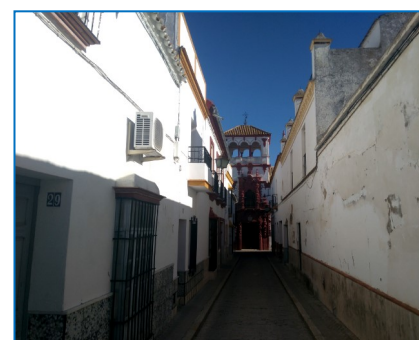
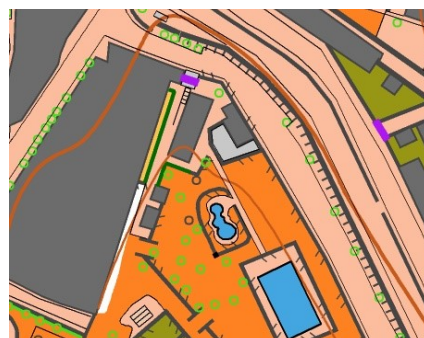

**MIDDLE DISTANCE AND LONG DISTANCE**

**RULE:** ISMTBO  
**SCALE:** MEDIA DISTANCIA: 1: 15000  
**LONG DISTANCE:** 1:20000  
**EQUIDISTANCE:** 5 METERS FOR BOTH  
**HALF PENDING:** 2%  
**LOCATION:** MARCHENA (SEVILLE)

Map of 40 km<sup>2</sup> with extensive network of roads.

The environment is composed of agricultural farms of cereals and olive groves, as well as small cores of grouped houses and great profusion of isolated building, which cause that there a lot of fences. In general it is a fairly flat area, with the ppresence of some very short section with greater slope in very pecific points.

**The cyclability is very hight** because what predominate are wide roads, which together with the extensión of the roads can facilitate high speeds.

**Network of roads:** The paths of goof cyclability (symbol 832) with the presence of some main tracks (831) predonimate. In the cases that low ciclability is mainly due to broken roads by passing agricultural machinery or sand áreas.

**IMPORTANT NOTES**

- 1- Due to the type of terrain, in case of intense rains in the days leading up to the competition, the ciclability can be reduced by one or two levels, as it is a terrain prone to mude formation.
- 2- Due to the agricultural activity we can find road markings of the passage of the machinery for crops, as well as plowed or not. A priori the crops are **NOT CYCLABLE ZONE**, as well as we indicate that this type of machinery brands, unless they are cosntant, have not been mapped.
- 3- In the case of areas between crops in which good ciclability or presence/traces of roads of little use have been estimated, of variable cyclability, but constant in time the **orange color has been used (839.2)**.
- 4- Transit of vehicles: Scarce, mostly agricultural vehicles.

**ABSOLUTE RESPECT FOR AGRICULTURAL PLANTATIONS AND ITS EQUIPMENT IS REQUESTED, AVOIDING CYCLING OUT OF ROADS OR DETERMINED AREAS AS CYCLABLE.**

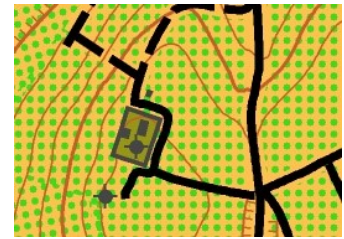



### COURSES

COURSES	CATEGORIES
R1	M-E
R2	F-E, M40, M21, M20, ABSOLUTA PAREJAS
R3	M50, F40, F21, F20
R4	M60, F50, M17, M15
R5	M70, F60, F17, F15, INI. PAREJAS
R6	F70, M/F12, M/F-INI, M/F-PROM.

### COURSE TECHNICAL INFORMATION

#### MIDDLE DISTANCE

**Start:** Clasic, con Interval between runners 2-3 minutos (pre-start of 20mn)

Race in which the average speed is going to be very high; It's very important to have a fast route choices due to this running speed.

#### MIDDLE DISTANCE INFORMATION

COURSE	DISTANCE	LEVEL	CONTROL
R1	30.200m	280m	29
R2	26.900m	250m	25
R3	23.700m	240m	22
R4	23.000m	230m	20
R5	18.300m	155m	15
R6	16.200m	140m	16

---

#### SPRINT

**Start:** Clasic, con Interval between runners 2-3 minutos (cuarentaine)

Race in which great speeds will be reached, in urban floor at all times.

To avoid mishaps the runner is advised to **always circulate on the right side of the road.**

**The vehicles will be cut off during the entire test.**



SPRINT INFORMATION

COURSE	DISTANCE	LEVEL	CONTROL
R1	8.950m	150m	39
R2	8.400m	130m	34
R3	7.600m	120m	28
R4	7.600m	120m	27
R5	7.200m	120m	26
R6	5.000m	100m	21

**MANDATORY PASSAGE:** The competitor os obliged to pass through this obligatory passage in th eroute choice, between two points.

These are passage in which the organization will be controlling its correct use.

**BALIZED PASSAGE:** The competitor must pass inside



LONG DISTANCE

STARTS:

**1- CHASING START (ONE MAN RELAY)** for courses R1, R2, R3 y R4 (pre-start 15mn). Due to the complexity of this departure, we are forced to increase the number of controls that would normally be in a long distance course. The starting order Will be marked by **the sum of the times of the Middle distance and the Sprint.**

**2- HOUR START** for courses R5 y R6, con Interval between runners 2-3 minutos (pre-start of 15mn)

This course Will also be characterized by its high speed.

COURSE	DISTANCE	LEVEL	CONTROL
R1	45.500m	439	33
R2	41.900m	419	27
R3	35.500m	353	24
R4	32.700m	300	24
R5	18.000m	164	11
R6	15.800m	147	10



**CASTILLEJA DE GUZMAN**

 **MAPA COMPLETO MTBO (2019)**

 **PUNTO DE RECOGIDA DE MAPAS (PICK UP POINT):**  
Teatro municipal Federico García Lorca  
AVENIDA CASTILLEJA DE LA CUESTA  
41908 CASTILLEJA DE GUZMAN  
REF. 37.408650, -6.058507  
**LUNES 25 A VIERNES 29, DE 8H A 19H**  
**MONDAY 25 TO FRIDAY 29, FROM 8PM TO 7AM**

 **PARKING GRATUITO (COCHES Y AUTOCARAVANAS)**  
FREE PARKING (CARS AND CAMPINGCARS)



**LA LUISIANA**

 **MAPA COMPLETO MTBO (2017/2019)**

 **PLAZA PARQUE FELIX RODRIGUEZ/ 41430 LA LUISIANA**  
REF. 37.524197, -5.251256

**PARKING GRATUITO (COCHES Y AUTOCARAVANAS)**  
FREE PARKING (CARS AND CAMPINGCARS)

**MISMO MAPA DEL MODEL EVENT / SAME MAP MODEL EVENT**

**RESERVAR MAPAS ENVIANDO UN CORREO A**  
**BOOK MAPS SENDING AN EMAIL TO**  
[inscripcion@montellano-o.es](mailto:inscripcion@montellano-o.es)  
3 euros / map

ORGANIZATION MODEL EVENT



**MODEL EVENT**

 **VIERNES 29/03/2019**  
**15H00**

 **CENTRO DE COMPETICIÓN**  
**PLAZA PARQUE FELIX RODRIGUEZ/ 41430 LA LUISIANA**  
REF. 37.524197, -5.251256

**SALIDA / START**  
**5mn CON BICI / 5mn WITH BIKE**

 **PARKING GRATUITO (COCHES Y AUTOCARAVANAS)**  
FREE PARKING (CARS AND CAMPINGCARS)

 **15H00 INICIO SALIDA (FIRST START)**  
**17H30 CIERRE DE META (LAST FINISH)**

 **LOS MAPAS DEL MODEL EVENT SE ENTREGAN EN EL**  
**CENTRO DE COMPETICIÓN DE LA LUISIANA ¡RESERVAR!**

**SERVICIOS / FREE SERVICES**



**FOR THOSE WHO START THIS SPORT WE RECOMMEND TO PARTICIPATE IN THE MODEL EVENT**

IT IS A TRAINING COURSE WITHOUT A TIMELINE

IDEAL TO UNDERSTAND THE SYMBOLOGY AND PRACTICE THE ORIENTATION OF THE MAP



MEDIA DISTANCIA / MIDDLE DISTANCE

- SÁBADO 30/03/2019**  
10H30
- CALLE MADRID 35 / 41620 MARCHENA**  
REF. 37.325347, -5.404583
- PARKING GRATUITO (COCHES Y AUTOCARAVANAS)**  
FREE PARKING (CARS AND CAMPINGCARS)
- 09H30 APERTURA SECRETARIA (SECRETARY OPEN)**  
**10H30 INICIO PRE-SALIDA (FIRST PRE-START)**  
**11H00 INICIO SALIDA (FIRST START)**
- GPS CON PANTALLA NO AUTORIZADO**  
GPS WITH SCREEN NOT ALLOWED

**SERVICIOS / FREE SERVICES**

ASEOS	AGUA	TRAINING AREA	CONSIGNA GET BAG



SPRINT

- SÁBADO 30/03/2019**  
15H30
- CENTRO DE COMPETICIÓN**  
**CALLE SANTA CATALINA, 1 / 41420 FUENTES DE AND.**  
REF. 37.463460, -5.351966
- ZONA CUARENTENA / QUARENTAINE AREA**  
5mn CON BICI / 5mn WITH BIKE
- PARKING GRATUITO (COCHES Y AUTOCARAVANAS)**  
FREE PARKING (CARS AND CAMPINGCARS)
- 14H30 APERTURA SECRETARIA (SECRETARY OPEN)**  
**15H30 CUARENTENA OBLIG. (COMPULSORY QUARENTAINE)**  
**16H00 INICIO SALIDA (FIRST START)**
- USO DE MOVIL O SMARTWATCH PROHIBIDO DURANTE TODA LA CUARENTENA (CONTROL DE LA ORGANIZACIÓN)**  
USE OF MOBILE OR SMARTWATCH PROHIBITED THROUGHOUT THE QUARENTAINE
- GPS CON PANTALLA NO AUTORIZADO**  
GPS WITH SCREEN NOT ALLOWED

**SERVICIOS EN CUARENTENA / FREE SERVICES**

ASEOS	AGUA	TRAINING AREA	CONSIGNA GET BAG

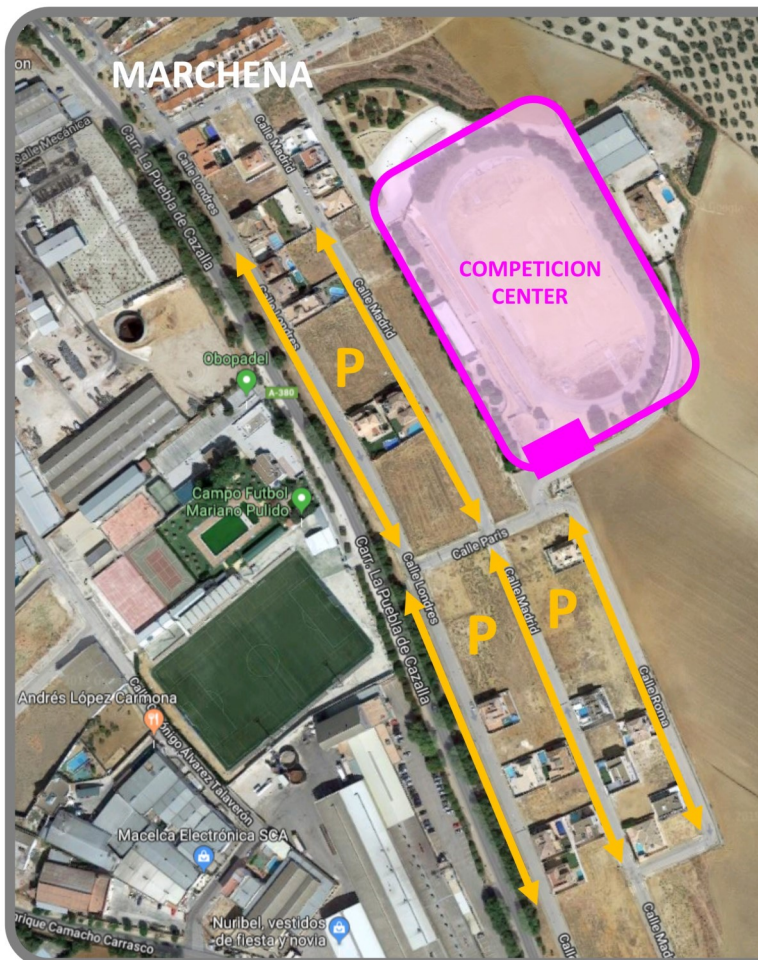

LARGA DISTANCIA / LONG DISTANCE

-  **DOMINGO 31/03/2019**  
9H10
-  **CALLE MADRID 35 / 41620 MARCHENA**  
REF. 37.325347, -5.404583
-  **PARKING GRATUITO (COCHES Y AUTOCARAVANAS)**  
FREE PARKING (CARS AND CAMPINGCARS)
-  **08H00 APERTURA SECRETARIA (SECRETARY OPEN)**  
**09H10 INICIO PRE-SALIDA (FIRST PRE-START)**  
**09H30 INICIO SALIDA A LA CAZA (FIRST CHASING START)**
-  **GPS CON PANTALLA NO AUTORIZADO**  
GPS WITH SCREEN NOT ALLOWED

**SERVICIOS / FREE SERVICES**

			
ASEOS	AGUA	TRAINING AREA	CONSIGNA GET BAG

**\*\* 2 STARTS IN LONG DISTANCE \*\***

Chasing start **“ONE MAN RELAY”** for courses **R1, R2, R3 y R4**  
Clasic Start for courses **R5 y R6** with intervale between 2-3 minutes

**INFORMACIÓN DETALLADA PARA LA SALIDA A LA CAZA “ONE MAN RELAY”**  
(primera vez que se organiza en España en carrera MTBO de Liga Nacional)

**1- The departure time** of each competitor will be determined taking into account their difference, in minutes and seconds, with respect to the first of their category in the average middle distance + sprint. This will be done with all competitors that have a difference of up to 30 minutes with respect to the first classified in its category. After 30 minutes from the start of the first runner of each of the categories, the runners who remain to start will do so at 1-minute intervals.

**Example:** An "A" runner from M-E in Saturday's race was 10 minutes and 28 seconds winner in this category. The first M-E runner on Sunday will leave at 10:00 and the "A" runner will depart at 10:10:28



2- The starting time will be displayed on the Hard Ground and website of the Montellano-O club from 9:00 p.m. the previous day. The start time will be available in the competition area from 8:00 on the day of competition.

3- The entrance of the competitor to the start area will be 5 minutes before its hour of beginning of the race. Any runner who arrives late to the departure area should notify the organization and make use of the specific street for late departures. No changes of time are allowed for any circumstance.

4- The race is "one man relay": Each course will have variations allowing to ensure fair play in the race. Upon entering the minute -5 the organization will inform the competitor of its map number (A, B, C or D)

5- It is the runner's responsibility to take the correct map, assigned by the organization in the area -5'

**CHASING START "ONE MAN RELAY"**

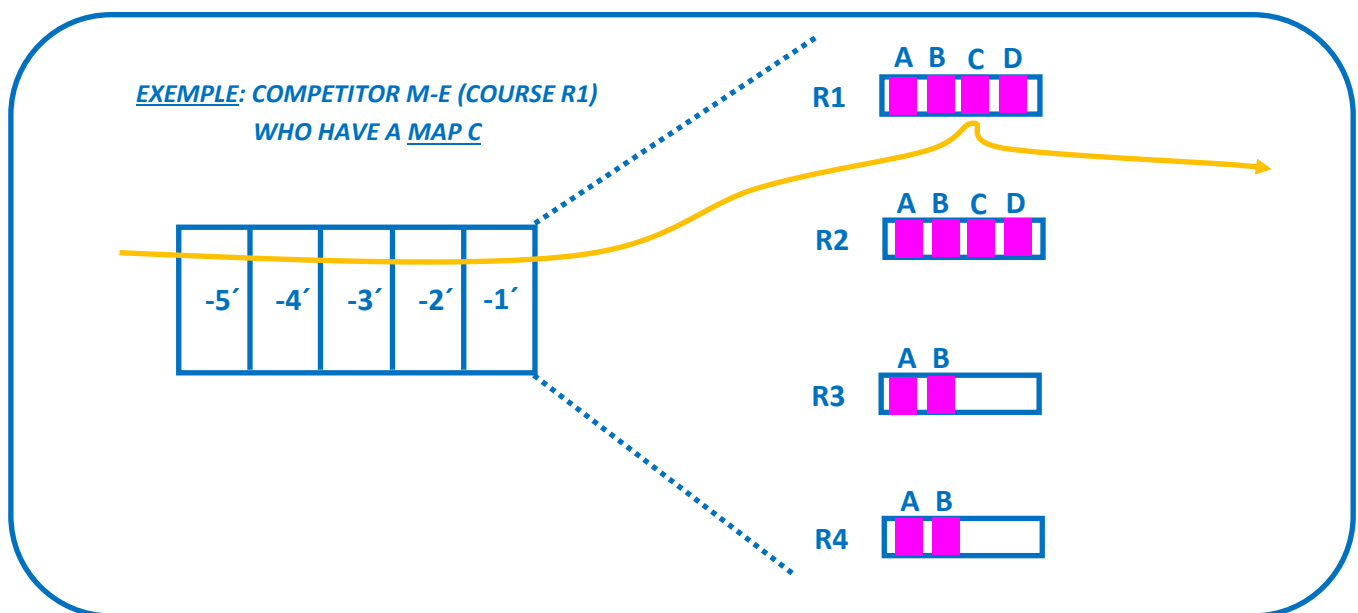

**MORE INFORMATIONS**

**STREAMING VIDEO OF THE 3 RACES**

WE REMEMBER THAT FOR THE FIRST TIME IN MTBO EVENT OF SPANISH LEAGUE

THE 3 RACES WILL HAVE A LIVE RETRANSMISSION OF 2H

THE STREAMING SYSTEM WILL BE USED AND CAN BE DISPLAYED ON THE YOUTUBE PLATFORM

LIVE STREAMING OF THE RACES ON: [WWW.MONTELLANO-O.ES](http://WWW.MONTELLANO-O.ES)

4 CAMERAS IN THE COURSE

1 START AREA CAMERA

1 FINISH AREA CAMERA WITH INTERVIEWS

LIVE RESULTS OF INTERMEDIARY TIMES AND FINAL TIMES

GPS TRACKING OF THE 30 BEST COMPETITORS

LIVE COMMENTATOR



DEPARTURE TIMES ARE ON [WWW.MONTELLANO-O.ES](http://WWW.MONTELLANO-O.ES)

## USE OF THE SIAC - **IMPORTANT**

*ITS OBLIGATED TO PAY A DEPOSIT OF 70 EUROS TO TAKE A SIAC.*

The manufacturer recommends to not pass the control point with a speed higher than 40km/h to make sure that the Siac connects correctly with the electronical control point. The beeping sound of the Siac assures you that the siac made a correct connection with the control point.

We recommend you to not go faster than 40 km/h when you cross the finish line.

Behind the finish line there will be a large zone to reduce your speed for all three races.

## SIZES OF THE MAPS - **IMPORTANT**

SPRINT MAP: 25X30CM

MIDDLE AND LONG DISTANCE MAP: 32X45CM (A3+)

MODEL EVENT MAP: 21X29,7CM (A4)

TRAINING MAP: 21X29,7CM (A4)

## PICK UP OF THE MIDDLE DISTANCE MAPS - **IMPORTANT**

At the finish line of the middle distance race the maps will be collected.

We will give the maps back after the long distance race in the Fuentes competition center (where the prize ceremony will be).

¡ CHANGE OF THE CLOCKS BETWEEN SATURDAY AND SUNDAY !

## WATER PROVISIONING ON THE LONG DISTANCE RACE - **IMPORTANT**

The organisation will provide 3 places to get some water on the long distance race. These places will be clearly marked on the map.

We don't provide this service for the medium distance race.

## DOUBLE SPORTIDENT CONTROL POINT IN THE LONG DISTANCE RACE - **IMPORTANT**

To prevent accidents the organisation decided to put two identical control points at points with a high passing rate. The two identical control points will be on opposite sides of the path within 3m of each other.

## JURY - **IMPORTANT**

Juez Controlador:	JESÚS DE MIGUEL REY (FEDO)
Representante de la Organización:	JUAN FRANCISCO ABELLÁN ORTIN (CD MONTELLANO)
Representante de Clubes:	JORGE GARCÍA PARDOS (PEÑA GUARA)
Suplente:	URBANO CHOUSA ÁLVAREZ (T-TRAGAME)
Representante de los Corredores:	ANA VARELA YAÑEZ (BRIGANTIA)

ALL THE SERVICES OF THE EVENT WILL BE PROVIDED TO THE COMPETITION CENTER OF FUENTES DE ANDALUCIA. SOME SERVICES REQUIRE RESERVATION AND PAYMENT IN ADVANCE.

### BAR SERVICE (CATERING OF THE EVENT)

PLACE: **Competition Center of Fuentes de Andalucía**  
 SCHEDULES: **Friday from 12:00 to 21:00**  
**Saturday from 9:00 to 21:00**  
**Sunday from 9:00 to 16:00**

Drinks low-cost prices, breakfast service at 2 euros (toast +coffee)

### LUNCH SERVICE (CATERING OF THE EVENT)

PLACE: **Competition Center of Fuentes de Andalucía**  
 SCHEDULES: **Friday from 13:00 to 15:00**  
**Saturday from 13:00 to 15:00**  
**Sunday from 13:00 to 15:00**

Menu at 8 euros:

**Friday** 1º-Mixed salad / 2º-Meatballs with rice / 3º-Fruit

**Saturday** 1º-Pasta salad / 2º-Meat in tomato with potatoes / 3º-Fruit

**Sunday** 1º-Mixed salad / 2º-Paella mixed / 3º-Fruit

Option of children´s menu at 6 euros: *(send an email to reserve it)*

**Everyday** 1º-Pasta salad / 2º-Pizza / 3º Fruit

### COMPULSORY RESERVE

- . ON THE ENTRY FORM FOR THE MENU AT 8 EUROS ACCORDING TO DAY
- . SUBSEQUENT TO YOUR REGISTRATION BY EMAIL TO [inscripcion@montellano-o.es](mailto:inscripcion@montellano-o.es) (menu 8 or 6 euros)
- . IF THERE ARE PLACES, IN THE COMPETITION CENTER THE SAME DAY OF THE EVENT

### KINDERGARTEN SERVICE

PLACE: **Competition Center of Fuentes de Andalucía**  
 SCHEDULES: **Saturday from 9:00 to 13:00 (MD) and from 15:00 to 18:00 (SP)**  
**Sunday from 8:00 to 13:00 (LD)**

Price: 1 euro/ race

### COMPULSORY RESERVE

- . ON THE ENTRY FORM
- . SUBSEQUENT TO YOUR REGISTRATION BY EMAIL TO [inscripcion@montellano-o.es](mailto:inscripcion@montellano-o.es)
- . IF THERE ARE PLACES, IN THE COMPETITION CENTER THE SAME DAY

**EVENT T-SHIRT**

PLACE: **Competition Center of Fuentes de Andalucía**

SCHEDULES: **Friday 12:00 to 21:00 / Saturday 9:00 to 21:00 / Sunday 9:00 to 16:00**

MEN	INTERN. SIZE	SPANISH SIZE	PECHO CHEST cm	CUELLO NECK cm
	S	44	88-92	38
	M	46/48	94-98	40
	L	50	100-104	42
	XL	52/54	106-110	44
	XXL	56/58	112-116	46

WOMEN	INTERN. SIZE	SPANISH SIZE	PECHO CHEST cm	CADERA HIP cm
	XS	34	78-81	86-89
	S	36	82-85	93-96
	M	38	86-89	97-100
	L	40	90-93	101-104
	XL	42	94-97	105-107
	XXL	44	98-101	108-112

CHILD	INTERN. SIZE	SPANISH SIZE	ALTURA HEIGHT
	6XS	3/4 años	98-110
	5XS	5/6 años	110-122
	4XS	7/8 años	122-134
	3XS	9/10 años	134-146
	2XS	11/12 años	146-158
	XS	13/14 años	158-170



Joma sports shirt. Round neck and two bands contrast color, soft and pleasant touch fabric, breathable and technical fast drying. Reinforced seams and flat to avoid friction. 100% polyester interlock.

Price: **10 euros (all sizes)**

**COMPULSORY RESERVE**

- . ON THE ENTRY FORM
- . SUBSEQUENT TO YOUR REGISTRATION BY EMAIL TO [inscripcion@montellano-o.es](mailto:inscripcion@montellano-o.es) (deadline 23/03)
- . IF THERE ARE UNITS, IN THE COMPETITION CENTER THE SAME DAY

**HARD FLOOR**

PLACE: **Polideportivo of Fuentes de Andalucía**

SCHEDULES: **Opening Friday at 12:00 - Closing Sunday at 16:00**

Price: **1 euro per night**

**COMPULSORY RESERVE**

- . ON THE ENTRY FORM INDICATED DAY(S)
- . SUBSEQUENT TO YOUR REGISTRATION BY EMAIL TO [inscripcion@montellano-o.es](mailto:inscripcion@montellano-o.es) (deadline 23/03)

**VIDEO AND PHOTOGRAPHY COMPANY**

**PLACE:** Competition Center of Fuentes de Andalucía  
+ Video and photographic service during the races

**SCHEDULES:** Friday 12:00 to 21:00 / Saturday 9:00 to 21:00 / Sunday 9:00 to 16:00

**VIDEO SERVICE**

Live broadcast of the field images of each competition commented by speaker José Pinto (with interviews and analysis of the results).

**PHOTOGRAPHY SERVICE**

Professional photographers in the field and in finish-line.

All photos will be published on large screens in the Competition Center after each race, and can be downloaded free of charge from the club's website [www.montellano-o.es](http://www.montellano-o.es)

**PERSONALIZED PHOTOGRAPHY SERVICE**

In the Competition Center you can enjoy a fun "Photocall" service with instant photo printing (10x15cm) at an economical price.

**TOURIST INFORMATION POINT**

**PLACE:** Competition Center of Fuentes de Andalucía

**SCHEDULES:** Friday from 12:00 to 21:00  
Saturday from 9:00 to 21:00  
Sunday from 9:00 to 16:00

All the tourist information of the area in brochures and free maps (trilingual service)  
Sponsored by the "Junta de Andalucía, Turismo y Deporte"



**TECHNICAL SERVICE FOR BIKES**

**PLACE:** Competition Center of Fuentes de Andalucía  
**SCHEDULES:** **Friday 12:00 to 21:00**  
**Saturday 9:00 to 21:00**  
**Sunday 9:00 to 16:00**

Free adjustments (sponsor of the event)  
Other prices according to requested arrangement

**SERVICE "FHYSIO SPORT CENTER"**

**PLACE:** Competition Center of Fuentes de Andalucía  
**SCHEDULES:** **Saturday from 13:00 to 15:00 and from 17:00 to 20:00**

Free trials of cycling biomechanical adjustments  
Free physiotherapy sessions (sponsor of the event)

**ORIENTEERING STORES**

**PLACE:** Competition Center of Fuentes de Andalucía  
**SCHEDULES:** **Friday from 12:00 to 21:00**  
**Saturday from 09:00 to 21:00**  
**Sunday from 09:00 to 16:00**

Clothing, MTBO accessories, SportIdent material  
Offers and raffles throughout the weekend (sponsors of the event)

**GASTRONOMIC PRODUCTS**

**PLACE:** Competition Center of Fuentes de Andalucía  
**SCHEDULES:** **Friday from 12:00 to 21:00**  
**Saturday from 09:00 to 21:00**  
**Sunday from 09:00 to 16:00**

Gastronomic products from Andalusia (oils, cheeses, cold meats, honey ...)  
Offers and raffles throughout the weekend (sponsors of the event)

**PRIZES RANKING FEDO MTBO 2018**

Award ceremony for the best classifieds of all official categories MTBO 2018

Day **Saturday March 30, 2018**  
Place **Competition Center of Fuentes**  
Time **19:30**

**PRIZES “II TROFEO VÍA VERDE DE LA CAMPIÑA”**

The first 3 classifieds of the sum of points MD + SP + LD will be awarded of all categories

Day **Sunday December 31, 2018**  
Place **Competition Center of Fuentes**

**MTBO TRAINING MAPS****Before and after event:**

MTBO training map close to **Castillera de Guzman, Seville** (map from november 2018)  
3 euros

**After event:**

MTBO training map **La Luisiana** (full map from 2017/2019)  
3 euros

*Reserve your maps sending an email at [inscripcion@montellano-o.es](mailto:inscripcion@montellano-o.es) (before 23/03)*

**NEXT PLUBLICATIONS****FINAL BULLETIN**

Publication on March 26 at [www.montellano-o.es](http://www.montellano-o.es)  
Hours of departure

**CONTACTS****ENTRY AND SERVICES**

[inscripcion@montellano-o.es](mailto:inscripcion@montellano-o.es)

**ORGANIZATION (event and sponsors)**

[presidente@montellano-o.es](mailto:presidente@montellano-o.es)



**CLUB MONTELLANO-O** (March 2019)

All the information in this bulletin is subject to posible modifications